

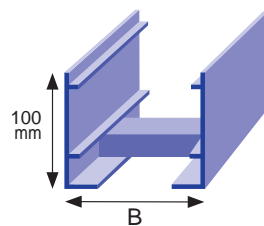

B	↔		
	1000 mm	2000 mm	3000 mm
100 mm	600 kg/m	450 kg/m	170 kg/m
200 mm	600 kg/m	400 kg/m	160 kg/m
300 mm	600 kg/m	350 kg/m	145 kg/m
400 mm	350 kg/m	280 kg/m	130 kg/m
500 mm	320 kg/m	260 kg/m	120 kg/m
750 mm	300 kg/m	240 kg/m	110 kg/m

L/150 = 0,75%



SH

kg
1,2 kg/m

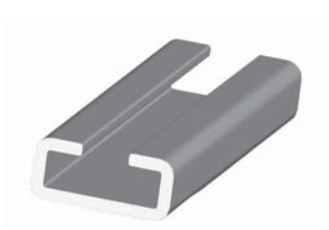

SP

kg
0,8 kg/m

B	kg
100 mm	2,8 kg/m
200 mm	3,0 kg/m
300 mm	3,3 kg/m
400 mm	3,5 kg/m
500 mm	3,8 kg/m

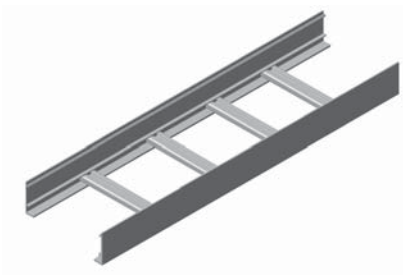

KL

B	kg
105 mm	0,7 kg/m
205 mm	1,2 kg/m
306 mm	2,1 kg/m
406 mm	2,7 kg/m
510 mm	5,3 kg/m

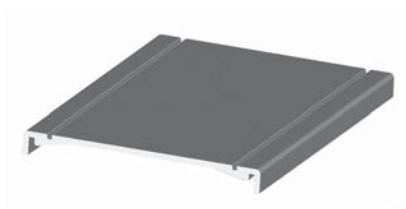

KD



B	kg
200/100 mm	2,8 kg
300/200 mm	2,9 kg
400/200 mm	3,0 kg
400/300 mm	3,1 kg
500/400 mm	3,3 kg

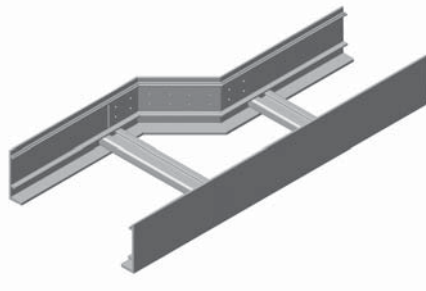

RMLi
RMRe

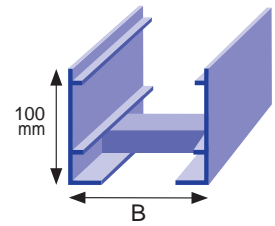

B	kg
200/100 mm	3,8 kg
300/200 mm	3,9 kg
400/200 mm	4,0 kg
400/300 mm	4,0 kg
500/400 mm	4,2 kg

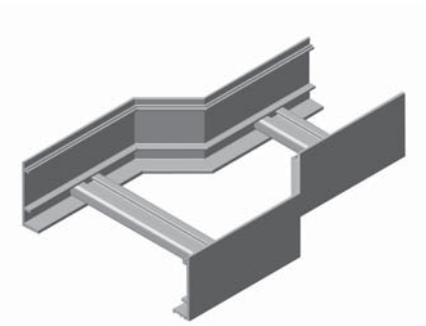

RMGR

B	kg
100 mm	3,3 kg
200 mm	3,6 kg
300 mm	3,8 kg
400 mm	4,1 kg
500 mm	4,3 kg

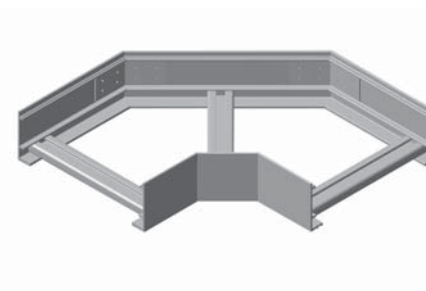

BH90

B	kg
100 mm	2,5 kg
200 mm	2,6 kg
300 mm	2,8 kg
400 mm	2,9 kg
500 mm	3,1 kg

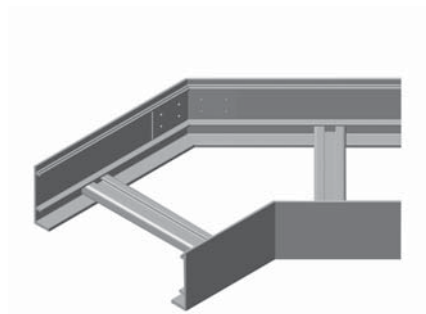

BH45

B	kg
100/100 mm	4,5 kg
200/200 mm	4,9 kg
300/300 mm	5,3 kg
400/400 mm	5,7 kg
500/500 mm	6,1 kg

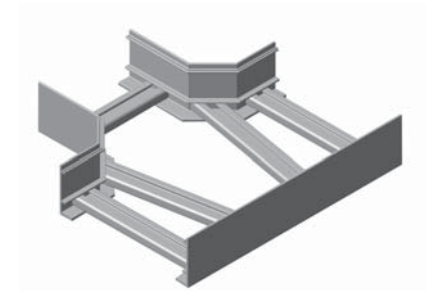

TM90



B	kg
100/100 mm	7,3 kg
200/200 mm	7,6 kg
300/300 mm	8,0 kg
400/400 mm	8,3 kg
500/500 mm	8,6 kg

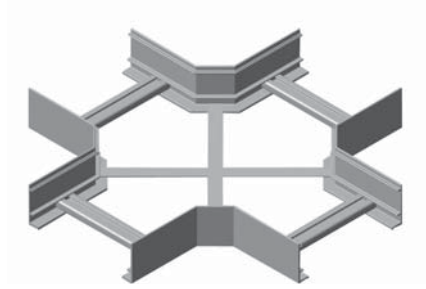

KM

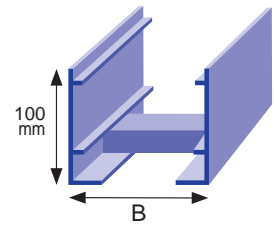

B	kg
100 mm	3,8 kg
200 mm	4,0 kg
300 mm	4,3 kg
400 mm	4,5 kg
500 mm	4,7 kg



BV90x

B	kg
100 mm	3,8 kg
200 mm	4,0 kg
300 mm	4,3 kg
400 mm	4,5 kg
500 mm	4,7 kg

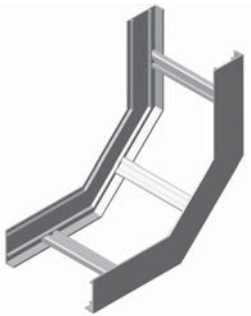

BV90v

B	kg
100 mm	2,4 kg
200 mm	2,6 kg
300 mm	2,8 kg
400 mm	2,9 kg
500 mm	3,1 kg

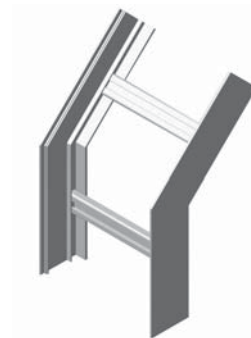

BV45x

B	kg
100 mm	2,4 kg
200 mm	2,6 kg
300 mm	2,8 kg
400 mm	2,9 kg
500 mm	3,1 kg

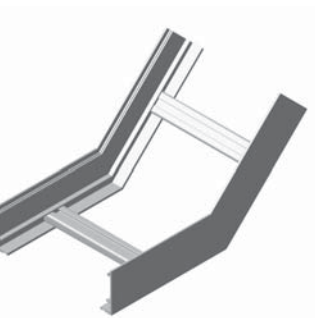

BV45v

